

Recycled Parts Request: 4-DOOR UNIBODY FORM

Date: _____

To: _____

Contact Person: _____

Phone #: _____

Year: _____

Model: _____

P.O. #: _____

From: _____

Contact Person: _____

Fax #: _____

Make: _____

VIN #: _____

Build Date: _____

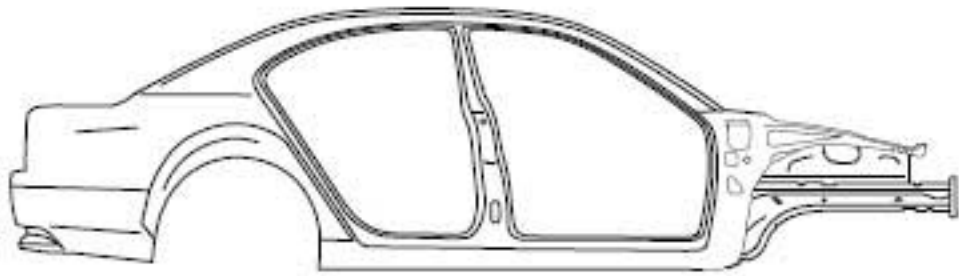

PASSENGER SIDE

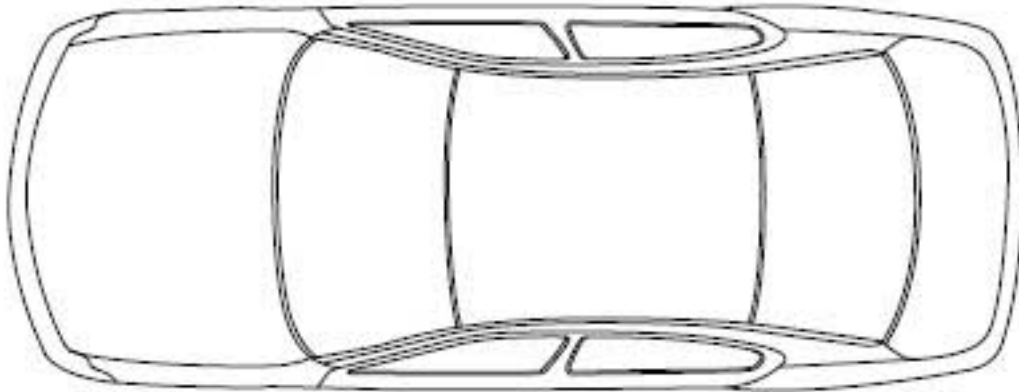
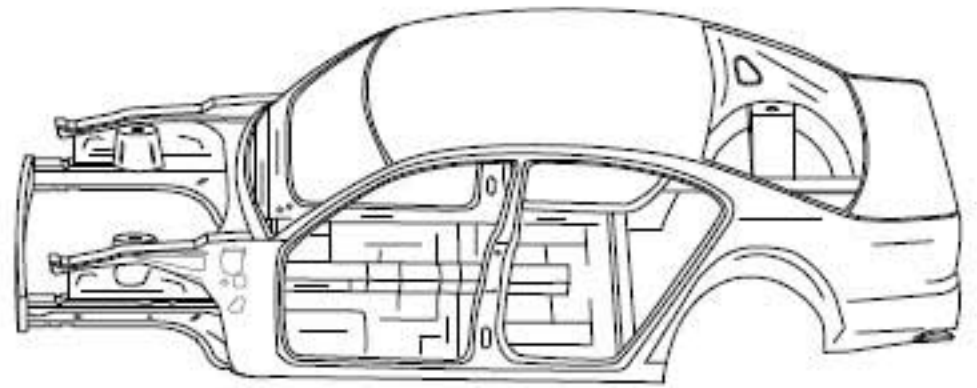

TOP VIEW

Please use the area below for a detail of cut instructions:

Notes:

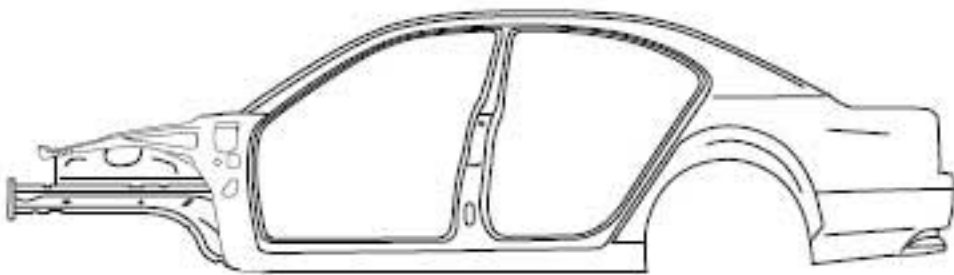

DRIVER SIDE

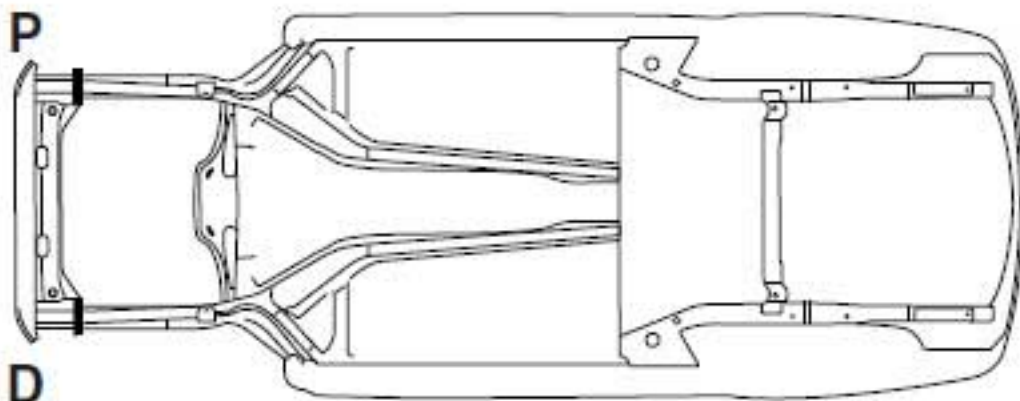

UNDERBODY VIEW